



PTU300 Combined Pressure, Humidity and Temperature Transmitter

For Demanding Applications



Features

- Barometric pressure, humidity, and temperature measurement in one transmitter
- RS-232C serial interface with NMEA protocol for GPS use
- Graphical display and keypad for convenient operation
- Analog outputs, RS-232/485, LAN
- Modbus protocol support (RTU/TCP)
- Traceable to international standards

Vaisala Combined Pressure, Humidity and Temperature Transmitter PTU300 is a unique instrument measuring three parameters simultaneously.

Options

- Available with up to two barometric pressure sensors for added reliability
- Optional universal power supply module
- HMT330MIK installation kit for outdoor use

You can choose from the following probe options: PTU301 for wall mounting for example in laboratories or engine rooms, PTU303 for general use, PTU307 warmed probe for outdoor and demanding meteorology applications, and PTU30T for pressure and temperature measurement only.

Proven Vaisala Sensor Technology

PTU300 incorporates sensors known for their high accuracy and excellent long-term stability: Vaisala BAROCAP® for pressure measurement and Vaisala HUMICAP® for humidity measurement. The temperature sensor is a platinum RTD sensor.

Graphical Display of Measurement Data and Trends for Convenient Operation

PTU300 features a large numerical and graphical display with a multilingual menu and keypad. It allows users to easily monitor operational data, measurement trends, and access measurement history for the past 12 months.

The optional data logger, with real-time clock, makes it possible to generate over four years of measurement history and zoom in on any desired time or time frame.

The display alarm allows any measured parameter to be tracked, with freely configurable low and high limits.

Versatile Outputs and Data Collection

PTU300 comes with a standard RS-232 serial interface. The output format is compatible with major GPS receivers and NMEA-coded messages. An isolated RS-485 interface is available as an option.

PTU300 is also capable of applying the Modbus communication protocol and, together with an appropriate connection option, provides either Modbus RTU (RS-485) or Modbus TCP/IP (Ethernet) communication.

The data logger records data that can be viewed on the local display or transferred to a PC with Microsoft® Windows® software. The transmitter can also be connected to a network with an optional LAN interface, which enables an Ethernet connection. A USB service cable makes it easy to connect PTU300 to a PC via the service port.

Outdoor Installation Kit

Outdoor installation is possible using the optional HMT330MIK installation kit, for applications requiring reliable measurements for meteorological purposes.

Flexible Calibration

Quick, one-point field calibration for humidity is easy using Vaisala Hand-Held Humidity Meter HM70.

With Vaisala Barometric Pressure Transfer Standard PTB330TS, including optional humidity and temperature probe, field check and calibration can be performed for all three parameters.

Applications

- Environmental monitoring in calibration laboratories
- Industrial applications in semiconductor industry, engine testing and maritime sector
- GPS meteorology: estimating precipitable water vapor in the atmosphere, weather stations

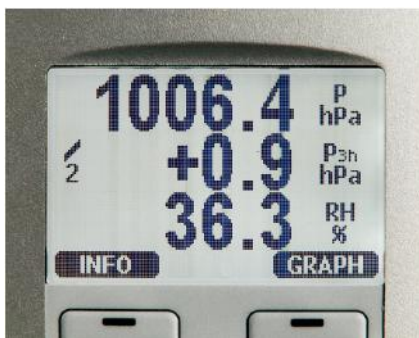

The display also shows the WMO pressure trend ΔP_{3h} and tendency of 0 ... 8.

Model

Dimensions in mm



PTU301 for wall mounting

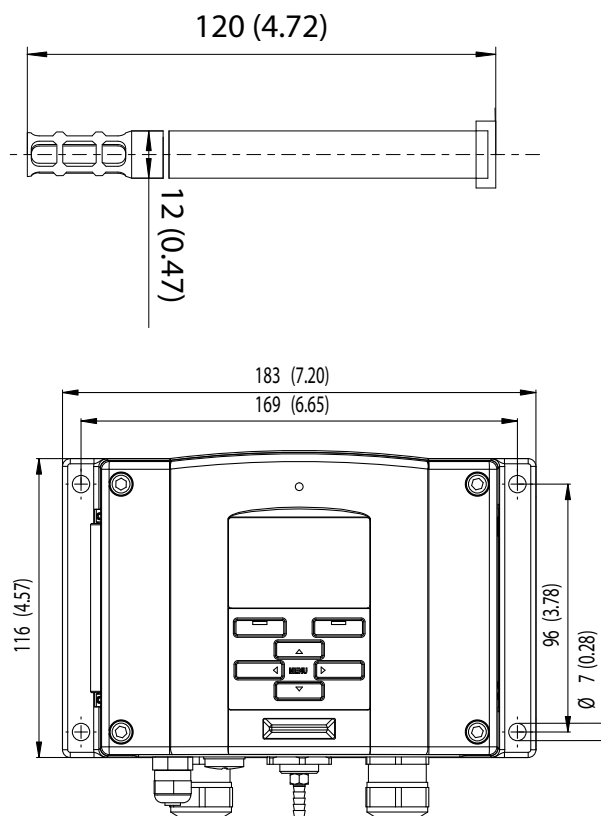

Model

Dimensions in mm

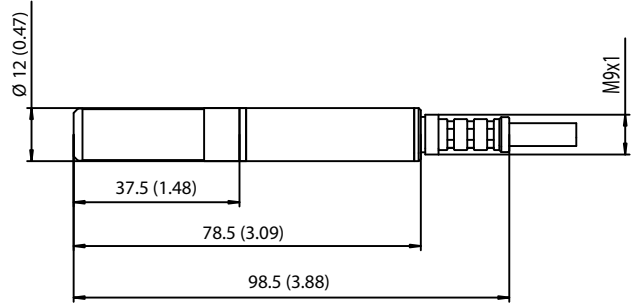

PTU303 probe for outdoor use

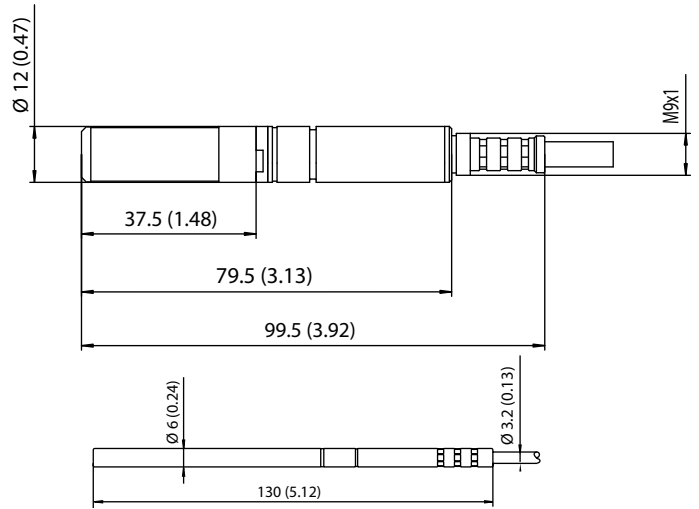

PTU307 warmed probe for demanding meteorological installations

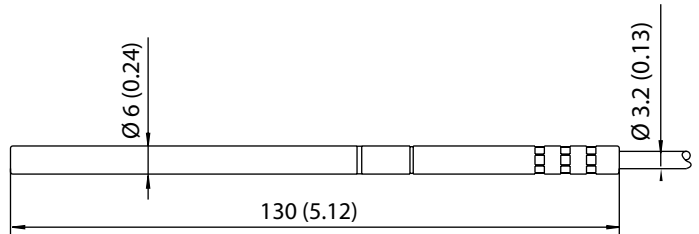

PTU30T for pressure and temperature only measurement

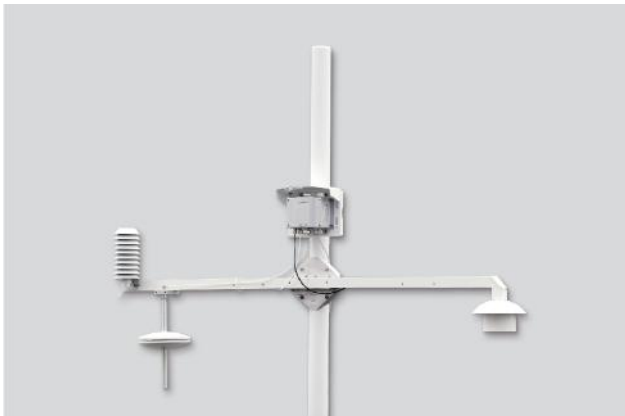

HMT330MIK Meteorological Installation Kit enables PTU307 to be installed outdoors to obtain reliable measurements for meteorological purposes.

Technical Data

Measurement Performance

Barometric Pressure

| Pressure range | 500 ... 1100 hPa | 50 ... 1100 hPa | 50 ... 1100 hPa |
|---|------------------|------------------|-----------------|
| Accuracy | 500 ... 1100 hPa | 500 ... 1100 hPa | 50 ... 1100 hPa |
| | Class A | Class B | |
| Linearity | ±0.05 hPa | ±0.10 hPa | ±0.20 hPa |
| Hysteresis | ±0.03 hPa | ±0.03 hPa | ±0.08 hPa |
| Repeatability | ±0.03 hPa | ±0.03 hPa | ±0.08 hPa |
| Calibration uncertainty | ±0.07 hPa | ±0.15 hPa | ±0.20 hPa |
| Accuracy at +20 °C / +68 °F | ±0.10 hPa | ±0.20 hPa | ±0.30 hPa |
| Temperature dependence | ±0.1 hPa | ±0.1 hPa | ±0.3 hPa |
| Total accuracy (-40 ... +60 °C / -40 ... +140 °F) | ±0.15 hPa | ±0.25 hPa | ±0.45 hPa |

| | | | |
|--------------------------|----------|----------|----------|
| Long-term stability/year | ±0.1 hPa | ±0.1 hPa | ±0.2 hPa |
|--------------------------|----------|----------|----------|

Response Time (100 % Response):

| | | | |
|------------|-----|----|-----|
| One sensor | 2 s | 1s | 1 s |
|------------|-----|----|-----|

Pressure units hPa, mbar, kPa, Pa, inHg, mmH2O, mmHg, torr, psia

Relative Humidity

| | |
|-------------------|---------------|
| Measurement range | 0 ... 100 %RH |
|-------------------|---------------|

Accuracy (Including Non-linearity, Hysteresis, and Repeatability):

| | |
|---|---|
| At +15 ... +25 °C / +59 ... +77 °F | ±1 %RH (0 ... 90 %RH) ±1.7 %RH (90 ... 100 %RH) |
| At -20 ... +40 °C / -4 ... +104 °F | ±(1.0 + 0.008 x reading) %RH |
| At -40 ... +60 °C / -40 ... +140 °F | ±(1.5 + 0.015 x reading) %RH |
| Factory calibration uncertainty (+20 °C / +68 °F) | ±0.6 %RH (0 ... 40 %RH) ±1.0 %RH (40 ... 97 %RH) |

(Defined as ±2 standard deviation limits. Small variations possible, see also calibration certificate.)

| | |
|--|-------------------------------|
| Sensor for typical applications | Vaisala HUMICAP 180 or 180R |
| Sensor for applications with chemical purge/warmed probe | Vaisala HUMICAP 180C or 180RC |

Response Time (90 %) at +20 °C (+68 °F) in Still Air:

| | |
|----------------------------------|---------------------------|
| With grid filter | 8 s / 17 s ¹⁾ |
| With grid + steel netting filter | 20 s / 50 s ¹⁾ |
| With sintered filter | 40 s / 60 s ¹⁾ |

Temperature

| | |
|--|--|
| Measurement range, housing (barometric pressure measurement limit) ²⁾ | -40 ... +60 °C (-40 ... +140 °F) |
| Measurement range, probes (operational limit when measuring RH or T) | PTU301: -40 ... +60 °C (-40 ... +140 °F) PTU303: -40 ... +80 °C (-40 ... +176 °F) PTU307: -40 ... +180 °C (-40 ... +356 °F) PTU30T: -70 ... +180 °C (-94 ... +356 °F) ³⁾ |
| Accuracy at +20 °C (+68 °F) | PTU301, PTU303, PTU307: ±0.2 °C (±0.4 °F) PTU30T: ±0.1 °C (±0.18 °F) |
| Temperature units | °C, °F |
| Temperature sensor | Pt100 RTD Class F0.1 IEC 60751 |

¹⁾ With HUMICAP 180R or 180RC sensor

²⁾ Note that the operational temperature limits of the PTU303, PTU307, and PTU30T probes are higher than for the PTU300 transmitter itself. The transmitter's temperature limit is based on the upper temperature limit for barometric pressure measurement, +60 °C (+140 °F)

³⁾ PTU30T is used for T and P measurements only, RH measurement not in use.

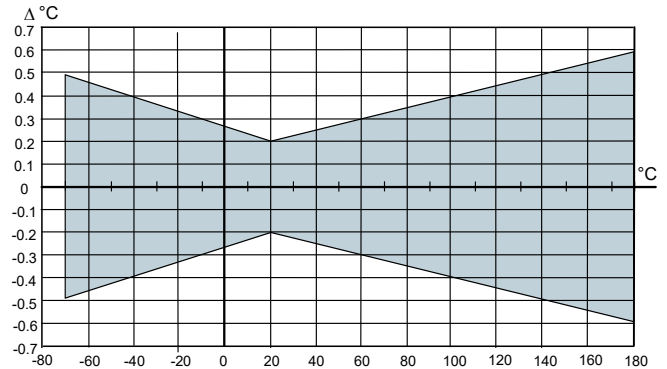

Accuracy over Temperature Range

Operating Environment

| | |
|---|-----------------------------------|
| Operating temperature | -40 ... +60 °C (-40 ... +140 °F) |
| Operating temperature with optional display | 0 ... +60 °C (+32 ... +140 °F) |
| Humidity range | Non-condensing |
| EMC compliance | EN61326-1, Industrial Environment |

Note: Transmitter with display test impedance of 40 Ω is used in IEC61000-4-5 (Surge immunity)

Mechanical Specifications

| | |
|--------------------------------------|--|
| Cable bushing | M20 x 1.5 for cable diameter 8 ... 11 mm / 0.31 ... 0.43" |
| Conduit fitting | 1/2" NPT |
| User cable connector (optional) | M12 series 8-pin (male) |
| Option 1 | Female plug with 5 m (16.4 ft) black cable |
| Option 2 | Female plug with screw terminals |
| Cable diameter, PTU303 | 6.0 mm |
| Cable diameter, other probes | 5.5 mm |
| Standard probe cable lengths | 2 m, 5 m or 10 m ¹⁾ |
| Housing material | G-AlSi10 Mg (DIN 1725) |
| IP rating | IP66 IP65 (NEMA4X) with local display |
| Weight (depending on selected probe) | 1.0 - 3.0 kg / 2.2 - 6.6 lb |

¹⁾ Additional cable lengths available, please see order form for details.

Optional Data Logger with Real-time Clock

| | |
|---|-------------------------------------|
| Logged parameters | Max. four with trend/min/max values |
| Logging interval | 10 s (fixed) |
| Maximum logging period with maximum temporal resolution | 4 years 5 months |
| Logged points | 13.7 million points per parameter |
| Battery lifetime | Min. 5 years |

Display

| | |
|----------------|--|
| Material | LCD with backlight, graphical trend display of any parameter |
| Menu languages | English, Chinese, Finnish, French, German, Japanese, Russian, Spanish, Swedish |

Inputs and Outputs

| | |
|-----------------------------------|-----------------------------|
| Operating voltage | 10 ... 35 VDC, 24 VAC ±20 % |
| With optional power supply module | 100 ... 240 VAC, 50/60 Hz |

| | |
|--|--------------|
| Settling time at power-up (one sensor) | Class A: 4 s |
| | Class B: 3 s |

| | |
|-----------------------|---|
| Recommended wire size | 0.5 mm ² (AWG 20) stranded wires |
|-----------------------|---|

| | |
|-----------------|---------------------------|
| Digital outputs | RS-232, RS-485 (optional) |
|-----------------|---------------------------|

| | |
|-----------|----------------------------|
| Protocols | ASCII commands, Modbus RTU |
|-----------|----------------------------|

| | |
|--------------------|-------------|
| Service connection | RS-232, USB |
|--------------------|-------------|

| | |
|--------------------------|----------------|
| Relay outputs (optional) | 0.5 A, 250 VAC |
|--------------------------|----------------|

Power Consumption at +20 °C (+68 °F) (U_{in} 24 VDC)

| | |
|--------|------------|
| RS-232 | Max. 28 mA |
|--------|------------|

| | |
|---|------------|
| U _{out} 3 x 0 ... 1 V / 0 ... 5 V / 0 ... 10 V | Max. 33 mA |
|---|------------|

| | |
|----------------------------------|------------|
| I _{out} 3 x 0 ... 20 mA | Max. 63 mA |
|----------------------------------|------------|

| | |
|-----------------------|--------|
| Display and backlight | +20 mA |
|-----------------------|--------|

| | |
|-----------------------|--------------|
| During chemical purge | Max. +110 mA |
|-----------------------|--------------|

| | |
|----------------------|---------|
| During probe heating | +120 mA |
|----------------------|---------|

External Loads

| | |
|-----------------|------------------------|
| Current outputs | R _L < 500 Ω |
|-----------------|------------------------|

| | |
|------------------|-----------------------|
| 0 ... 1 V output | R _L > 2 kΩ |
|------------------|-----------------------|

| | |
|----------------------------------|------------------------|
| 0 ... 5 V and 0 ... 10 V outputs | R _L > 10 kΩ |
|----------------------------------|------------------------|

Ethernet Interface (Optional)

| | |
|---------------------|----------------------|
| Supported standards | 10BASE-T, 100BASE-TX |
|---------------------|----------------------|

| | |
|-----------|-------------|
| Connector | 8P8C (RJ45) |
|-----------|-------------|

| | |
|-------------------------|--------------------------|
| IPv4 address assignment | DHCP (automatic), static |
|-------------------------|--------------------------|

| | |
|-----------|-----------------------|
| Protocols | Telnet, Modbus TCP/IP |
|-----------|-----------------------|

Analog Outputs (Optional)

| | |
|----------------|--------------------------|
| Current output | 0 ... 20 mA, 4 ... 20 mA |
|----------------|--------------------------|

| | |
|----------------|----------------------------------|
| Voltage output | 0 ... 1 V, 0 ... 5 V, 0 ... 10 V |
|----------------|----------------------------------|

Humidity and Temperature:

| | |
|---|--------------------|
| Accuracy of analog outputs at +20 °C (+68 °F) | ±0.05 % full scale |
|---|--------------------|

| | |
|--|---|
| Temperature dependence of analog outputs | ±0.005 %/°C (0.003 %/°F) full scale outputs |
|--|---|

Pressure:

| | |
|---|------------------------------|
| Accuracy of analog outputs at +20 °C (+68 °F) | ±0.30 hPa (500 ... 1100 hPa) |
| | ±0.40 hPa (50 ... 1100 hPa) |

| | |
|--|------------------------------|
| Accuracy of analog outputs at -40 ... +60 °C / -40 ... +140 °F | ±0.60 hPa (500 ... 1100 hPa) |
| | ±0.75 hPa (50 ... 1100 hPa) |

Spare Parts and Accessories

| | |
|--|-----------|
| PC software and cable | 215005 |
| USB-RJ45 Serial Connection Cable | 219685 |
| Connection cable for HM70 | 211339 |
| Wall mounting plate (plastic) | 214829 |
| Pole installation kit with rain shield | 215109 |
| DIN rail installation set | 211477 |
| Duct installation kit, PTU303/307 | 210697 |
| Cable gland and AGRO, PTU303/307 | HMP247CG |
| Solar radiation shield, PTU303/307/30T | DTR502B |
| Meteorological installation kit | HMT330MIK |
| Duct installation kit (T probe) | 215003 |

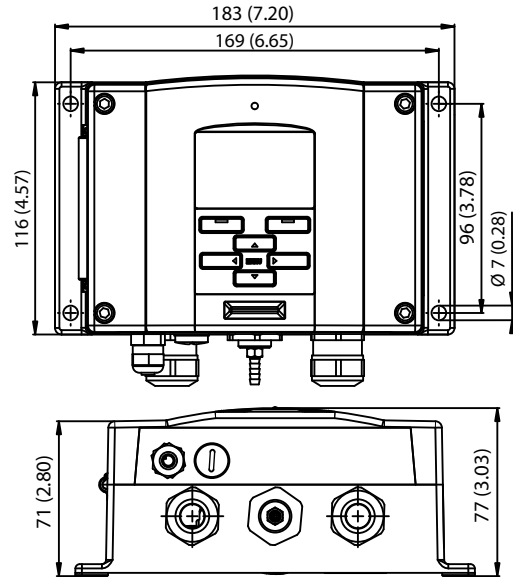

Dimensions in mm (inches)

