

Properties

The standard range of ceramic infrared elements in stock are used in a wide range of industrial and engineering applications such as thermoforming, packaging, paint curing, printing, drying, gluing, sterilisation, roasting etc. They are also very effectively used in infrared outdoor heaters and saunas.

Most plastics and many other materials absorb infrared best in the wavelength range of 2-10 μm , which makes the ceramic heater the most popular radiant emitter on the market.



Technical specification

Material	Ceramic solid body in white glaze colour with an embedded resistance heating coil
Heater Voltage	230 V (standard)
Operating Temperature	Max permissible 750°C
Useful wave-length range	2 - 10 μm (microns) long wavelength
Dimensions	122 x 60 x 34 mm
Average weight	105 g
Electric connection	100 mm ceramic beaded power leads
Assembly	Recommended radiation distance from heater is 100mm to 200mm. Mounting slot size oval 15x42 mm Steel wave spring and clip set included
Recommended Spacing	5mm minimum spacing between elements
Average operating life	Up to 20 000 hrs depending on conditions
Standards	CE, UL-499
Packaging w x h x d	126 x 62 x 44 mm



Standard assortment

Model HTE	Power W	Mean Surface Temperature °C	Max Power Density kW/m ²
HTE 125	125	351	15
HTE 150	150	405	18
HTE 200	200	480	24
HTE 250	250	515	30
HTE 300	300	561	36
HTE 325	320	596	39
HTE 400	400	636	48
HTE 500	500	726	60

HTE - Half Trough Element

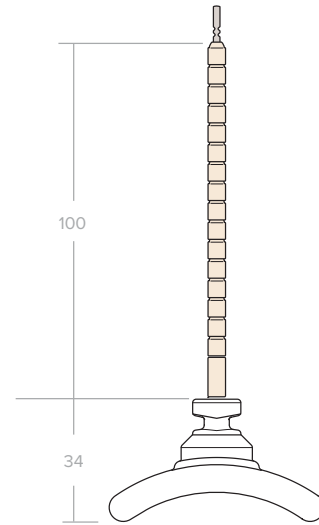
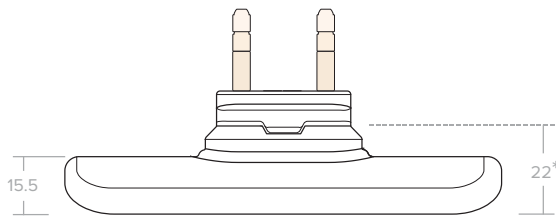
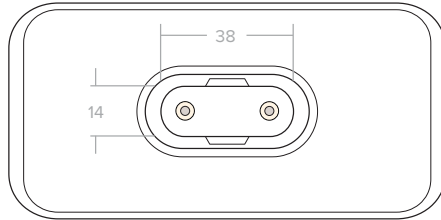
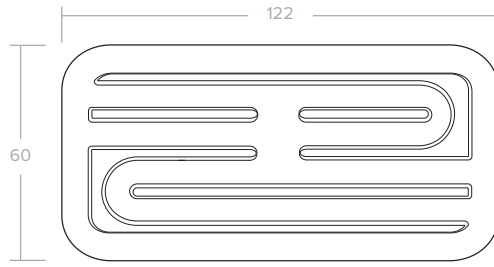

HTE HALF TROUGH ELEMENT

24.0719
Tolerances apply, all dimensions mm.
* Face of reflector - face of element using 0.75mm reflector, mounting slot size 15 x 42 mm.

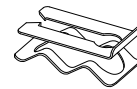

Comes with Wave Spring and Clip



Recommended Slot hole size 42 x 15 mm

1.6535" x 0.5905"

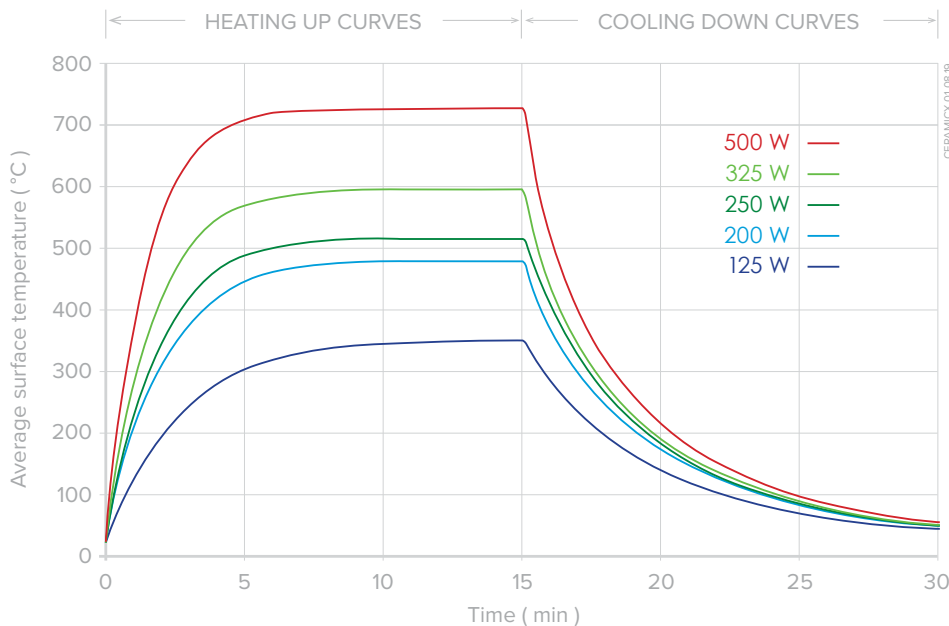
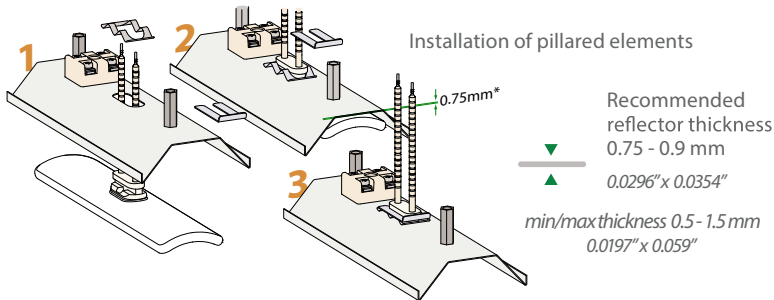

HTE Half Trough Element

Heating up and cooling down curves showing average surface temperature taken with an infrared thermometer set at an emissivity of 0.95 (Element mounted in an aluminised steel reflector RAS)