



www.fine-tek.com

## Vibrating Probe Level Switch



# PRODUCT INTRODUCTION

## WORKING PRINCIPLE

The Finetek vibrating probe switch is highly versatile and can be used for most almost any bulk solid application. This includes level detection of almost any granular, sandy, chip like, foodstuff, grain or powdery materials.

The operating principle is based on the changes of vibration frequency of the tuning fork when it comes into contact with a liquid or solid material..

The Vibrating probe contains piezoelectric crystals built into the vibration tube that produce vibrations/resonations at specific frequencies. One element acts as a transmitter of the signal and the other receives the signal and converts it to electrical output.

When the Vibrating probe comes in contact with material the vibration is weakened/dampened and results in a frequency change which triggers the switch. It's ideal for applications where: the dielectric constant is low (where capacitance level switches can't be used) ; when material moisture content changes easily; low viscosity liquids; there is a combination of differing materials in the container/tank.

The Vibrating probe provides a reliable & maintenance-free means of process control for bulk solids. Easy mounting at almost any angle and basic calibration procedures will provide reliable functioning and less required monitoring. This device can withstand tough lateral loads and static electricity.

Furthermore, it eliminates the application issues associated with jamming and clogging between tines on a 'tuning fork' device Also; it is equipped with a Fail-safe that prevents malfunctioning caused by power cuts

## FEATURES

- Voltage supply range 20~250, 50~60Hz Vac/ Vdc.
- SPDT Relay output, SSR MOSFET output.
- Sensitivity adjustment is available for different density mediums.
- Low wear and tear, maintenance free and self cleaning.
- Fine powders can be detected.
- Euro and UL certified Models available.

## APPLICATION

Solid Level Detection

Powders:

Powdered milk, flour, spices, coffee beans, coffee powder, tea, salt, sugar, grains, chocolate  
Tobacco, powdered cellulose, powdered clay, polystyrene powder, dry soot, soda ash, coal ash

**Granular & plastics:**

Gravel, glass fine power, granular plastics, foundry sand, cements, plastic pellets

**Chip or pellet like:**

Frozen potato chips, beans, peanuts, sweets and candy, animal / pet food  
Wood shavings, chalk, steering chips, styrofoams, charcoals

## BENEFITS

- No calibration required, easy use, sturdy and durable
- Rounded design prevents medium build up on probe
- Operates well under high temperature, humid and moist conditions
- High vibration force (also helps shake off build up)
- Fine powers can be detected.

## STRUCTURE & DIMENSION

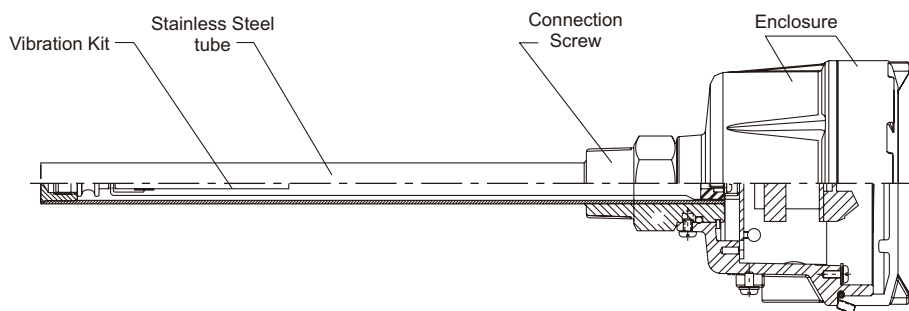

# SPECIFICATIONS

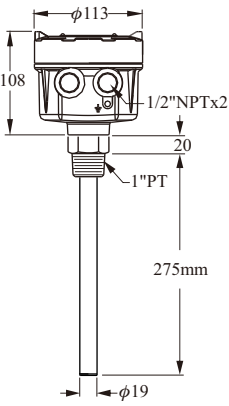
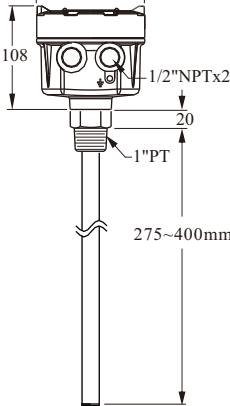
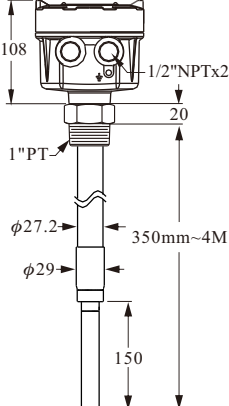
Dimensions (Unit:mm)			
<b>Order No.</b>	<b>SC2100</b> 【Standard Model】	<b>SC2110</b> 【Probe Extension Model】	<b>SC2120</b> 【Ultra Extension Model】
<b>Level sensor housing</b>	Aluminum / IP65		
<b>Probe construction</b>	SUS 304 / 316		
<b>Mounting</b>	1"PT		
<b>Conduit</b>	1/2"NPT × 2		
<b>Max. vertical load on rod.</b>	177in.Lbs(20Nm)		
<b>Operating pressure.</b>	-1~150PSI (10BAR)		
<b>Power supply</b>	20~250, 50/60Hz Vac/ Vdc		
<b>Power consumption</b>	15VA (Max.)		
<b>Ambient temp.</b>	-40°C~60°C		
<b>Medium temp.</b>	-40°C~80°C		
<b>Signal output</b>	Relay, SPDT, 3A/250Vac, 3A/28Vdc, PNP/NPN(MOSFET)400mA/60 Vac/ Vdc		
<b>Min. material density sensed</b>	Solid: ≥0.32g/cm <sup>3</sup>		
<b>Time delay</b>	0.6~1 Second / Operate; 2~5 Seconds / Reset		
<b>Remote-test</b>	Yes		
<b>Vibrating frequency.</b>	395~405HZ		
<b>Selectable Fail-safe</b>	Hi./ Lo.		
<b>Selectable sensitivity</b>	Hi./ Lo.		

# SPECIFICATIONS

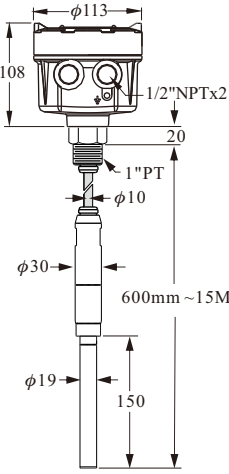
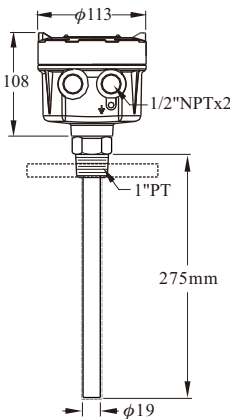
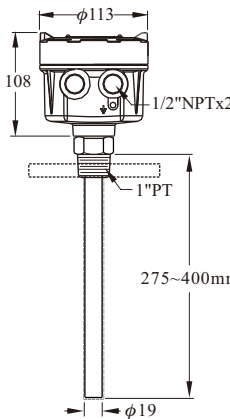
<b>Dimensions</b> (Unit:mm)			
<b>Order No.</b>	<b>SC2300</b> 【Cable Extension Model】	<b>SC2500</b> 【Corrosion-Proof】	<b>SC2510</b> 【Corrosion-Proof & Extension Typ】
<b>Level sensor housing</b>	Aluminum / IP65		
<b>Probe construction</b>	SUS 304 / 316	SUS 304/316 Coating TEFLON	SUS 304/316 Coating TEFLON
<b>Mounting</b>	1"PT	Flange 1"(min.)	Flange 1"(min.)
<b>Conduit</b>	1/2"NPT×2		
<b>Max. vertical load on rod.</b>	177in.Lbs(20Nm)		
<b>Operating pressure.</b>	-1~150PSI (10BAR)	-1~150PSI (10BAR)	-1~150PSI (10BAR)
<b>Power supply</b>	20~250, 50/60Hz Vac/ Vdc		
<b>Power consumption</b>	15VA (Max.)		
<b>Ambient temp.</b>	-40°C~60°C		
<b>Medium temp.</b>	-40°C~80°C		
<b>Signal output</b>	Relay, SPDT, 3A/250Vac, 3A/28Vdc, PNP/NPN(MOSFET)400mA/60 Vac/ Vdc		
<b>Min. material density sensed</b>	Solid: $\geq 0.32\text{g/cm}^3$		
<b>Time delay</b>	0.6~1 Second / Operate; 2~5 Seconds / Reset		
<b>Remote-test</b>	Yes		
<b>Vibrating frequency.</b>	395~405HZ		
<b>Selectable Fail-safe</b>	Hi./ Lo.		
<b>Selectable sensitivity</b>	Hi./ Lo.		

# EXPLOSION PROOF TYPE

Dimensions (Unit:mm)			
<b>Order No.</b>	<b>SC1700</b> <b>【 Standard Type 】</b>	<b>SC1701</b> <b>【 Probe Extension Type 】</b>	<b>SC1710</b> <b>【 Ultra Extension Type 】</b>
<b>Level sensor housing</b>	Aluminum		
<b>Probe construction</b>	SUS 304 / 316		
<b>Mounting</b>	Screw: 1"PT or PF, Flange: 1"~6"JIS / DIN / ANSI		
<b>Conduit</b>	1/2"NPT×2		
<b>Max. vertical load on rod.</b>	177in.Lbs(20Nm)		
<b>Operating pressure.</b>	-1~150PSI (10BAR)		
<b>Power supply</b>	20~250Vac/dc		
<b>Power consumption</b>	15W		
<b>Ambient temp.</b>	-20°C~70°C		
<b>Medium temp.</b>	-40°C~80°C		
<b>Signal output</b>	Relay, SPDT , 3A/250Vac, 3A/28Vdc (Only NEPSI)		
<b>Min. material density sensed</b>	Solid: ≥0.32g/cm <sup>3</sup>		
<b>Time delay</b>	0.6 Second / Operate; 2~5 Seconds / Reset		
<b>Vibrating frequency.</b>	395~405HZ		
<b>Selectable Fail-safe</b>	Hi./ Lo.		
<b>Selectable sensitivity</b>	Hi./ Lo.		

# INSTALLATION

## Vertical Installation (Figure 1):

1. Install the vibrating probe away from the inlet to avoid material impact or false readings.
2. Note the material flow pattern and place the vibrating probe in the appropriate position to avoid overflow.

## Horizontal Installation (Figure 2)

1. Install the vibrating probe away from the inlet to avoid material impact. If this is unavoidable make use of a shield or barrier for protection.
2. Installing the vibrating probe at a 20 degree incline will optimize the results and increase sensitivity.
3. Keep the conduit facing downward to avoid moisture getting inside the housing.

## Notice:

1. Users are advised to tighten the connection by using a spanner.
2. Do not bend the probe, put force on it or attempt to modify the probe length.
3. The maximum vertical pressure of the vibrating probe is 177in.Lbs (20Nm)

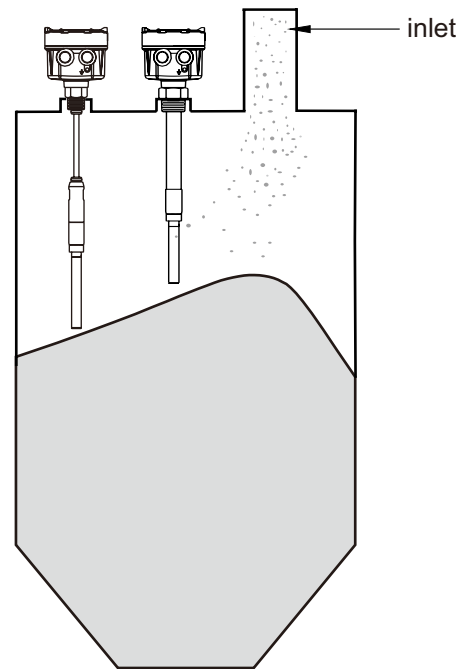

Figure 1

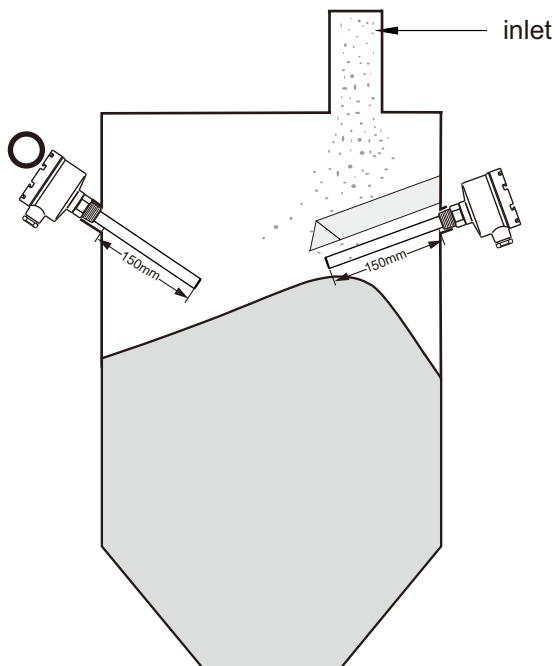

Figure 2

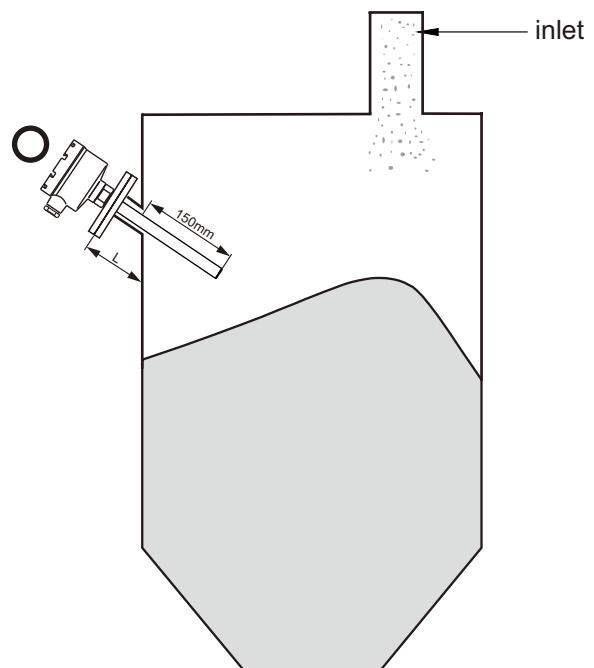
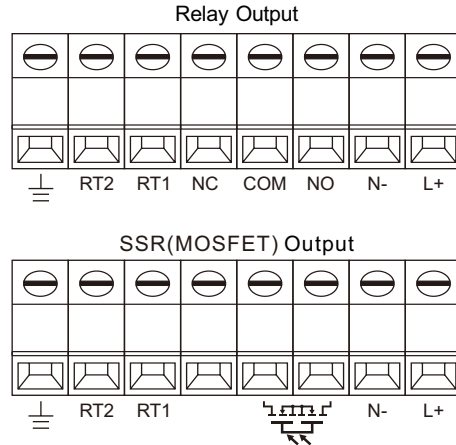
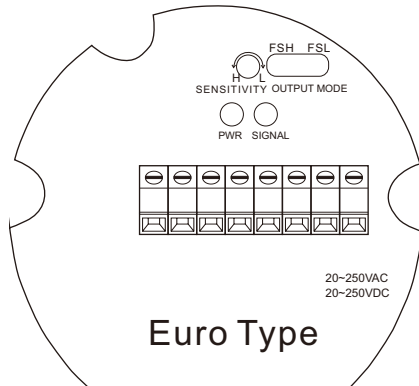



Figure 3

# OPERATING INSTRUCTIONS (EURO TERMINAL)

SC2100X, SC2110X, SC2200X, SC2210X, SC2300X, SC2500X, SC1700X, SC1701X, SC1710X



## Terminal Function

- L+, N-: Power Supply
- NC, COM, No: Relay Output
- RT1, RT2: Remote-Test
- $\perp$  : Ground Connection
-  : SSR(MOSFET) Output

## Panel Function

- PWR: Power Supply (Green Light)
- SIGNAL: Output Indication (Red Light)
- FSH: Power On. The signal lamp is on and the relay is conductive. While the vibrating probe senses the material, the signal lamp is off and relay is not conductive.
- FSL: Power On. The signal lamp is off and the relay is not conductive. While the probe senses the material, the signal lamp is on and relay is conductive.
- SENSITIVITY L: Low Sensitivity
- SENSITIVITY H: High Sensitivity

## Sensitivity Adjustment

1. SENSITIVITY: Located upside of PCB. When switching to H position, it has the highest sensitivity. When switching to L position, it has the lowest sensitivity. The original setting is at L position and users are able to adjust the sensitivity depends on the specific gravity of material.

- H: High Sensitivity  
(Suitable for detecting low specific gravity material)
- L: Low Sensitivity  
(Suitable for detecting low specific gravity material)

## Fail-Safe High / Low Protection

### FSH (Fail-Safe High) Protection:

Switch to FSH mode.

Normal Status: The signal lamp is on. It means that the vibrating probe does not sense the material and the relay is conductive.







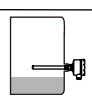
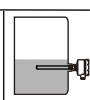
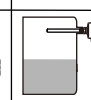
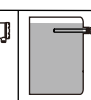

Failure: When the power shuts down, the signal lamp is off. It means that the vibrating probe is voided and the relay is not conductive.

### FSL (Fail-Safe Low) Protection:

Switch to FSL mode.

Normal Status: The signal lamp is on. The vibrating probe senses the material and the relay is conductive.

Failure: When the power shuts down, the signal lamp is off. The vibrating probe is voided and the relay is not conductive.

	FSL		FSH	
Level				
Contact Form				
Indication				
Status	Fail	Normal	Normal	Fail

# OPERATING INSTRUCTIONS (BARRIER TERMINAL)

SC2100X, SC2110X, SC2120X, SC1700X, SC1701X, SC1710X

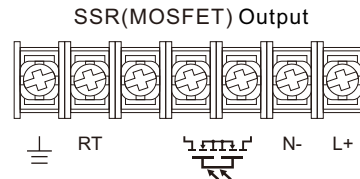
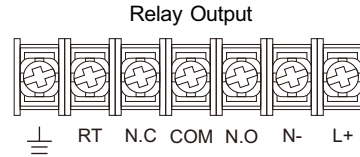
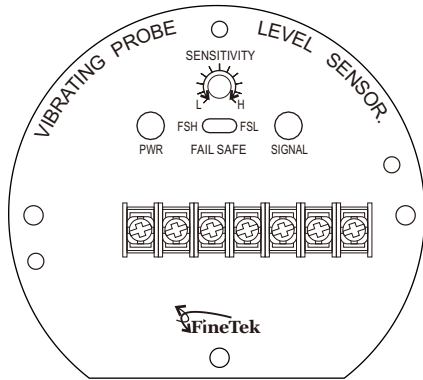

## Terminal Function

- L+, N-: Power Supply
- NC, COM, No: Relay Output
- RT: Remote-Test
- $\equiv$  : Ground Connection
-  : SSR(MOSFET) Output

## Panel Function

- PWR: Power Supply (Green Light)
- SIGNAL: Output Indication (Red Light)
- FSH: Power On. The signal lamp is on and the relay is conductive. While the vibrating probe senses the material, the signal lamp is off and relay is not conductive.
- FSL: Power On. The signal lamp is off and the relay is not conductive. While the probe senses the material, the signal lamp is on and relay is conductive.
- SENSITIVITY L: Low Sensitivity
- SENSITIVITY H: High Sensitivity

## Sensitivity Adjustment

1. SENSITIVITY: Located upside of PCB. When switching to H position, it has the highest sensitivity. When switching to L position, it has the lowest sensitivity. The original setting is at L position and users are able to adjust the sensitivity depends on the specific gravity of material.

- H: High Sensitivity  
(Suitable for detecting low specific gravity material)
- L : Low Sensitivity  
(Suitable for detecting low specific gravity material)

## Fail-Safe High / Low Protection

### FSH (Fail-Safe High) Protection:

Switch to FSH mode.

Normal Status: The signal lamp is on. It means that the vibrating probe does not sense the material and the relay is conductive.













Failure: When the power shuts down, the signal lamp is off. It means that the vibrating probe is voided and the relay is not conductive.

### FSL (Fail-Safe Low) Protection:

Switch to FSL mode.

Normal Status: The signal lamp is on. The vibrating probe senses the material and the relay is conductive.

Failure: When the power shuts down, the signal lamp is off. The vibrating probe is voided and the relay is not conductive.

Level	FSL		FSH	
				
Contact Form				
Indication				
Status	Fail	Normal	Normal	Fail



## MODEL NUMBER / ORDER CODE COMPARISON TABLE

---

---

---

---

---

---

---

---

---

---

Model Number	Order Code
SC2100	SCX10000-AAA
SC2110	SCX10000-BAA
SC2120	SCX10000-CAA
SC2300	SCX10000-DAA
SC2500	SCX10000-EAA
SC2510	SCX10000-FAA
SC1700	SCX100□□-AAA
SC1701	SCX100□□-BAA
SC1710	SCX100□□-CAA

# ORDER INFORMATION

⑦ ⑧
⑨
⑫
⑬
⑭
⑮
⑯
⑰
⑱
⑲
⑳
㉑
㉒
㉓
㉔
㉕
㉖

**SCX1 0 0**     -   **AA**                                

⑦ ⑧ **Certification**

00: None  
 1C: ATEX-Exd  
 7C: NEPSI-EXd

⑨ **Type**

A: Standard  
 B: Probe Extension type  
 C: Ultra Extension type  
 D: Cable Extension type  
 E: Corrosion-proof type  
 F: Corrosion-proof & Extended type

⑫ **Power supply**

A: 20~250VacVdc 50/60Hz; Relay O/P- Barrier terminal  
 B: 20~250VacVdc 50/60Hz; SSR(MOSFET) - Barrier terminal  
 C: 20~250VacVdc 50/60Hz; Relay O/P Euro terminal  
 D: 20~250VacVdc 50/60Hz; SSR(MOSFET) - Euro terminal

**Connection**

<p>⑬ ⑭</p> <p>Flange</p> <p>AK: JIS-FF</p> <p>AN: ANSI-RF</p> <p>AS: DIN-FF</p> <p>Thread</p> <p>AC: ANSI</p> <p>AA: JIS</p>	<p>⑮ ⑯</p> <p>A8: 1"</p> <p>B1: 1-1/2"</p> <p>B2: 2"</p> <p>B4: 2-1/2"</p> <p>D8: DN25</p> <p>D9: DN32</p> <p>E1: DN40</p> <p>E2: DN50</p> <p>E3: DN65</p>	<p>⑰ ⑱</p> <p>01: PT male</p> <p>03: PF male</p> <p>07: NPT male</p> <p>40: 5 kg/cm<sup>2</sup></p> <p>42: 10 kg/cm<sup>2</sup></p> <p>48: 150 Lbs</p> <p>49: 300 Lbs</p> <p>57: PN10</p> <p>58: PN16</p>
---	--	---

⑲ ⑳ **Probe material**

MA: SUS 304      MB: SUS 316      MC: SUS 316L

㉑ ㉒ **Coating material**

14: PFA      34: ECTFE      00: None

※Only Corrosion-proof type and Corrosion-proof & Extended type can be coated with materials.

㉓ ㉔ ㉕ ㉖ **Length**

Code	Probe Length
0275	Standard
0275~0400	275~400mm
0600~A150	600~15000mm



# Global Network

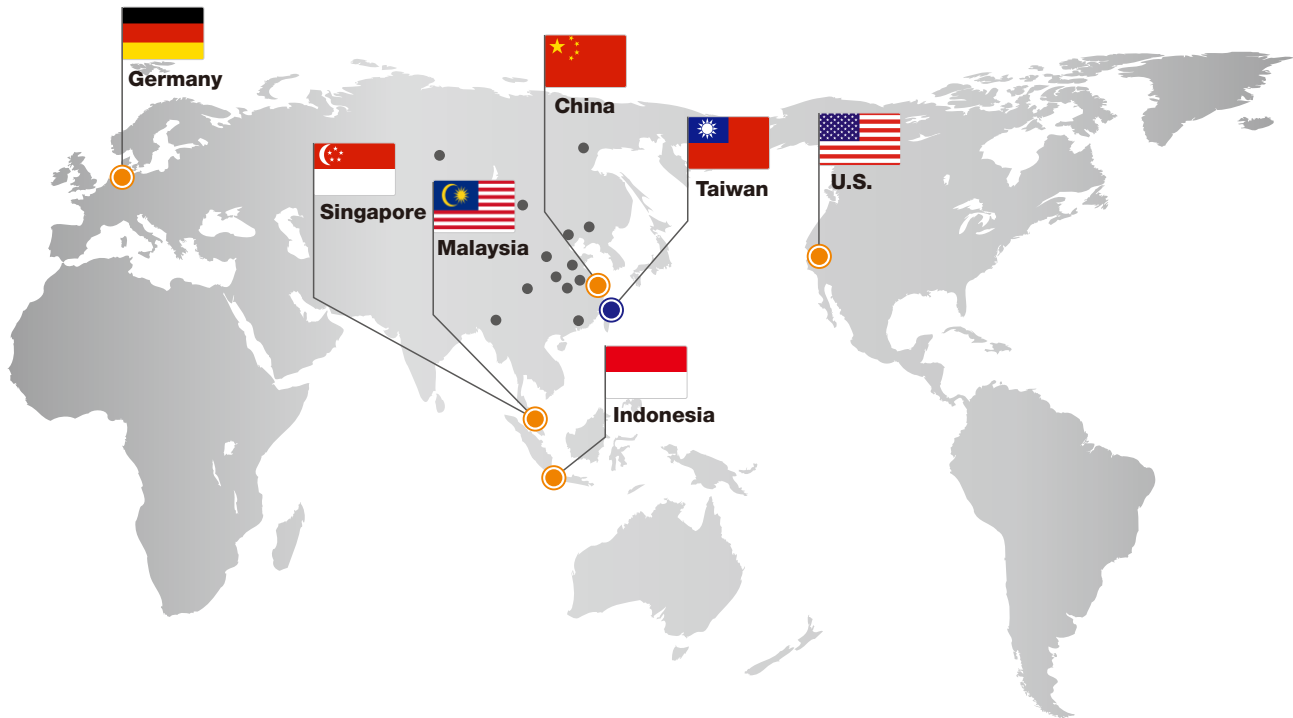

## ■ Head Quarte

### ● Taiwan

**FineTek Co., Ltd. - Taipei Head Quarter**   
No.16, Tzuchiang St., Tucheng Industrial Park  
New Taipei City 236, Taiwan  
TEL: 886-2-2269-6789  
FAX: 886-2-2268-6682  
EMAIL: info@fine-tek.com

## ■ North America

### ● California, U.S.

**Aplus Finetek Sensor Inc. - US Office**  
355 S. Lemon Ave, Suite D, Walnut,  
CA 91789  
TEL: 1 909 598 2488  
FAX: 1 909 598 3188  
EMAIL: info@aplusfine.com

## ■ Europe

### ● Germany

**FineTek GmbH - Germany Office**  
Bei den Kämpen 26  
21220 Seevetal-Ramelsloh, Germany  
TEL: +49-(0)4185-8083-12  
FAX: +49-(0)4185-8083-80  
EMAIL: info@fine-tek.de

## ■ Asia

### ● China

**Fine automation Co., Ltd. - Shanghai Factory**   
No.451 DuHui Rd, MinHang District, Shanghai,  
China 201109  
TEL: 86-21-6490-7260  
EMAIL: info.sh@fine-tek.com

### ● Singapore

**FineTek Pte Ltd. - Singapore Office**  
37 Kaki Bukit Place, Level 4 Singapore 416215  
TEL: 65-6452-6340  
EMAIL: info.sg@fine-tek.com

### ● Indonesia

**PT. FineTek Automation Indonesia - Indonesia Office**   
Tunas Bitung Industrial Park Blok C3 No.12 dan No.15  
Jalan Raya Serang Km.13.8 Kabupaten Tangerang 15710 Banten  
TEL: 62 (021)-2958-1688  
EMAIL: info.id@fine-tek.com

### ● Malaysia

**FineTek Co., Ltd. - Malaysia Office**  
8-05, Plaza Azalea, Persiaran Bandaraya,  
Seksyen 14, 40000 Shah Alam, Selangor, Malaysia  
TEL: 603-5524-7168  
EMAIL: info.my@fine-tek.com

### ● Müttec Instruments GmbH - Germany Office

Bei den Kämpen 26  
21220 Seevetal-Ramelsloh, Germany  
TEL: +49-(0)4185-8083-0  
FAX: +49-(0)4185-8083-80  
EMAIL: muetec@muetec.de



Distributor: