

Pressure sensors for general application

with front flush diaphragm
for gauge pressure and absolute pressure

Accuracy 0.25% and 0.5%

Standard output: 4 ... 20 mA; 2-wire system
or 0 ... 5 VDC; 3-wire system
or 0 ... 10 VDC; 3-wire system



Description

Pressure sensors for general application are top of the range pressure transducers.

Their accuracy, reliability, resistance to corrosion and mechanical load make them suitable for all pressure measuring tasks - in production, development or in the laboratory.

The front flush pressure diaphragm avoids zones, in which medium could crystallize or residues could form, thus ensuring trouble-free pressure measurement and hygienic cleaning of the pressure sensors.

The measuring ranges, graded in accordance with EN, range from 0,1 bar to 600 bar. The case and wetted parts comprise stainless steel and are thus resistant to chemically aggressive media. With the aid of an integrated cooling element, the sensors can be supplied with medium temperatures of up to 150 °C.

For more difficult measuring tasks (e.g. hydrostatic column), two potentiometers enable the zero point and measuring range to be set.

The pressure sensors for general application meet the electronic magnetic compatibility (EMC) requirements to EN 61 326.

Features

- o For pasty or crystallizing media
- o Finely graded selection of nominal ranges according to EN
- o Corrosion resistant, stainless steel design
- o High overload protection
- o Highly resistant to shock and vibration
- o For dynamic or static measurements
- o Good reproducibility
- o Integrated cooling element for medium temperatures of up to 150° C

Measuring Ranges

Gauge pressure

Negative -1 ... 0 bar to -0,1 ... 0 bar

Positive 0 ... 0.01 bar to 0 ... 600 bar

Absolute pressure 0 ... 0.25 bar to 0 ... 16 bar

Applications

Process engineering,

Plant and apparatus construction,

Development and laboratory applications

Models: P3251

Technical data

Model	P3251						Option
Pressure type	negative or positive gauge pressure			absolute pressure			negative or positive gauge pressure
Output signal	4 ... 20 mA - 2-wire system 0 ... 5 VDC - 3-wire system 0 ... 10 VDC - 3-wire system						other signals on request
Accuracy % of F. S. 1)	0,5	0,25	0,5	0,25	0,5	0,25	
Ranges accord. to EN	0 ... 0.1 bar 2) to 0 ... 16 bar		0 ... 25 bar to 0 ... 600 bar		0 ... 0,25 bar to 0 ... 16 bar		
Sensor element	piezoresistive		thin film		piezoresistive		
Repeatability	≤ ± 0.05% of F. S.						
Stability (annual)	≤ ± 0.2% of F. S. in rated conditions						
Case	Stainless steel						
Pressure connection	≤ 0...1,6 bar G 1 B; ≥ 0...2,5 bar G 1/2 B						
Wetted parts	Stainless steel						
Overload limit	≤ 16 bar 3,5 x; ≤ 600 bar 2 x;						
Electrical connection	plug according to DIN EN 175301-803 form A with junction box round connector M12x1; 4-pin						cable outlet with 1 m cable
Power supply	10 ... 30 VDC (14 ... 30 VDC for output 0 ... 10 V)						
Power consumption	output 4 ... 20 mA: signal currency voltage output: 8 mA						
Load	≤ $\frac{UB - 12 V}{0.020 A}$ for output (0) 4 ... 20 mA > 5 kOhm for output 0 ... 5 V > 10 kOhm for output 0 ... 10 V						
Temp. compens. range	0 ... 80 °C						
Temperature influence							
- Zero point	± 0.2% / 10 K 3)						
- Measuring range	± 0.2% / 10 K						
Adjustability	zero point and full scale up to ± 10%						
Response time	≤ 1 ms (within 10% to 90% of F. S.)						
Protection type	IP 65 to EN 60 529 / IEC 529						IP 67 for cable outlet
Emission 4)	according to EN 61 326						
Interference 4)	according to EN 61 326						
Electrical protection types	polarity, overload and short-circuit protection						
Temperature ranges							medium temperature -40 ... 125 °C
- Storage	-40 ... 100 °C						
- Medium	-30 ... 100 °C						
- Ambient	-20 ... 80 °C						integrated cooling element for temperatures up to 150° C
Weight	approx. 0.2 kg						

of F. S. = of full scale value

1) 0.25% accuracy for ranges ≥ 0.25 bar

2) For ranges < 0.1 bar: model P3275; technical data as model P3276;
wetted parts 1.4571, Si, Al and Au; only applicable for dry and non aggressive gases

3) ≥ 0 ... 2500 bar; M 16 x 1.5 female

4) ≤ ± 0,4%/10 K for measuring ranges 0 ... 0.1 and 0 ... 0.16 bar

5) Declaration of conformity on request

Dimensions

Case

Plug according to DIN EN 175301-803 form A

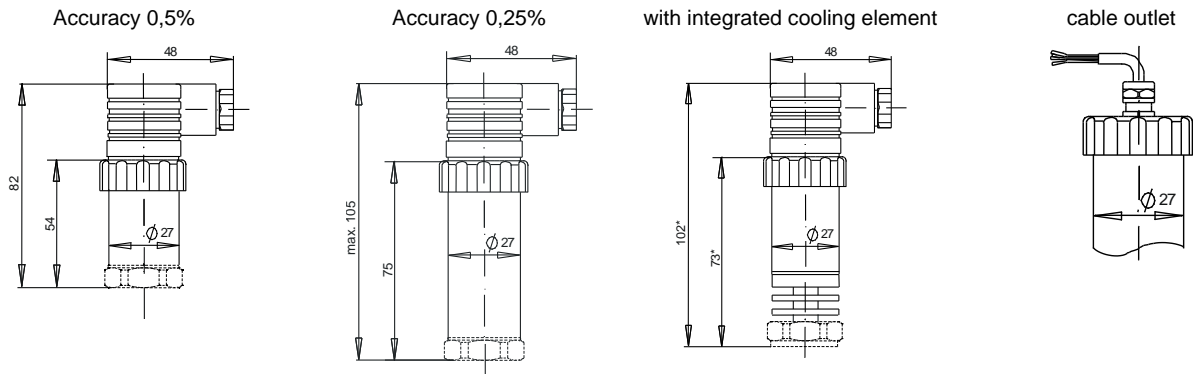

* for long version + 22 mm

Pressure connections

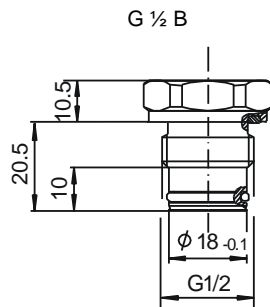

A-004

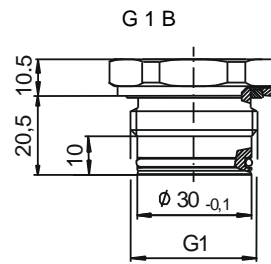

A-005

weld-on socket or screw-in aperture

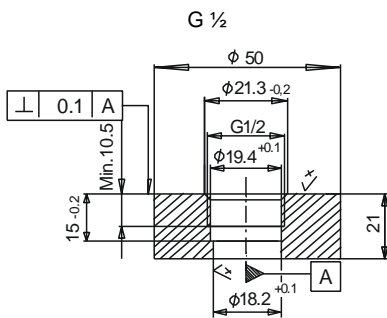

S-003

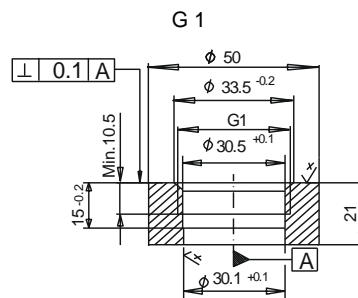

S-004

Electrical connection

Two-wire system

DIN EN 175301-803 form A plug

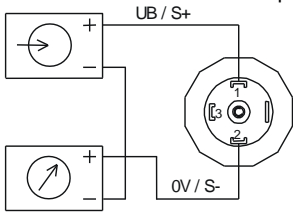

E-001

MIL-plug PT 02 E-10 6P

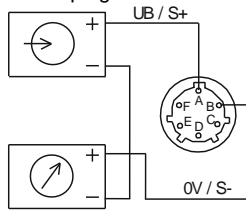

E-011

5-pin plug

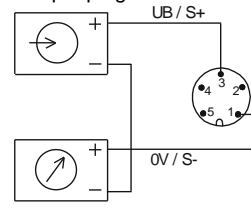

E-035

cable outlet

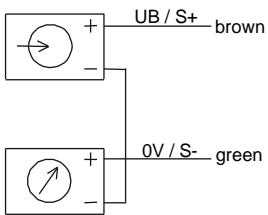

E-015

M12x1

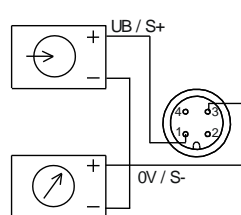

E-033

Three-wire system

DIN EN 175301-803 form A plug

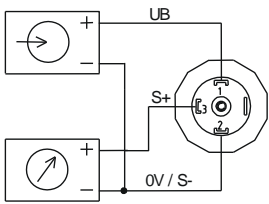

E-002

MIL-plug PT 02 E-10 6P

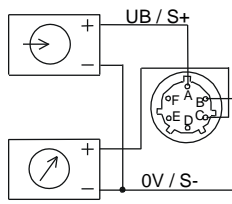

E-012

5-pin plug

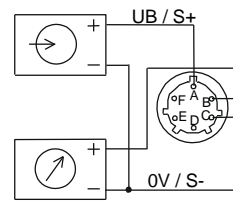

E-012

cable outlet

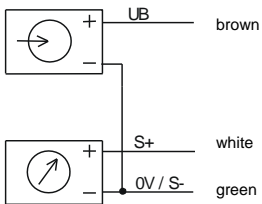

E-017

M12x1

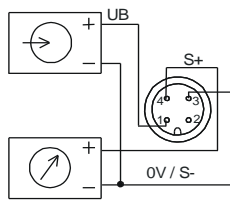

E-034

Connection table for DIN plug or cable outlet

	4 ... 20 mA (2-wire)		0 ... 10 VDC (3-wire)	
Supply: UB+	1	brown	1	brown
Supply: 0V	2	green	2	green
Signal: S+	---	-----	3	white
Signal:	---	-----	2	green

Order details

1. Model
2. Measuring range
3. Output signal
4. Options

Modifications reserved