

WM3

Digital wattmeter

- Display valid power by measuring the RMS
- Voltage and correct measurement type so converter not needed
- Max measurement range 200V AC
- Various output
(Relay 4–20mA DC open collector)



D

Panelmeter

● Suffix code

Model	Code	Information
WM3-	<input type="checkbox"/> <input type="checkbox"/> <input type="checkbox"/>	Digital wattmeter (DIN 96 X 48 mm)
Phase and wire	1	Single phase 2 wire type (0 – 220 V AC)
Input specification	01	Refer to the input specification (Refer to the code)
Output (optional)	N	Only for displaying
	0	Relay (HI, GO, LO), 4 – 20 mA DC
	1	Relay (HI, GO, LO)
	2	NPN Open collector (HI, GO, LO), 4 – 20 mA DC
	3	PNP Open collector (HI, GO, LO), 4 – 20 mA DC
	4	NPN Open collector (HI, GO, LO), RS485
	5	PNP Open collector (HI, GO, LO), RS485

● Input specification

Code	Information		
01	XXX : 5 A	Universal current transformer	Set current transformer ratio (C.T purchase separately)
02	XXX : 1 A	Universal current transformer	Set current transformer ratio (C.T purchase separately)
03	0 – 2.5 A	Exclusive current transformer (H-1W)	0 – 500.0 W max. (C.T included)
04	0 – 5 A		0 – 1100.0 W max. (C.T included)
05	0 – 10 A		0 – 2200.0 W max. (C.T included)
06	0 – 15 A		0 – 3300.0 W max. (C.T included)
07	0 – 30 A	Exclusive current transformer (H-2W)	0 – 6600.0 W max. (C.T included)
08	0 – 50 A		0 – 11,00 KW max. (C.T included)
09	0 – 80 A	Exclusive current transformer (H-4W)	0 – 17,60 KW max. (C.T included)
10	0 – 100 A		0 – 22,00 KW max. (C.T included)
11	0 – 150 A	Exclusive current transformer (H-5W)	0 – 33,00 KW max. (C.T included)
12	0 – 200 A		0 – 44,00 KW max. (C.T included)

Specification

Input

Measurement method	Period measuring type
Input voltage	0 – 220 V AC
Displaying period	0.1 ~ 2 sec
Power factor	80 ~ 100 %
Response speed	Approx. 2 sec (max range)
max displayable digit	4 digits (-1999 ~ 9999)
Displaying part	7 segments LED

Performance

Classification	Information
Accuracy	Less than ± 5 Digt
Insulation resistance	Min 100 M Ω (500 V DC)
Dielectric strength	1500 V AC for 1 min (power terminal – input terminal)

Function

Measurement list	AC power(W)
Average value indication	It is hard to measure the precise value when measurement value varies too much. In this case, it average the PV and display it. In other words, setting 2 in the parameter mode "ADC" will measure the value twice repeatedly, get the average and display the value.
Scale function	Change the high and low measured value of input signal to a certain value and display it.
Set position of decimal point	Selection done by internal parameter
Hold	Stop measuring due to the external contact signal (hold) and maintain the indication value right before applying the hold signal.
Max/Min value indication	Indicate the max/min value of the measurement values.
Communication function	RS485 communication
RMS measurement function	RMS counting measurement method regarding the distorted wave shape.
Position of a decimal point	Select the position of a decimal point.
Hold function	Memorize the max input value or min input value or become hold (stop) due to the external signal.
Lock function	Limits the set function of each parameter.
Address	Assign the address when using the communication function.
Communication speed	Set the communication speed (bps).
Max value indication	Display the max value of indicated value which being measured.
Min value indication	Display the min value of indicated value which being measured.
High setting	Set the high set value(HSET) of high output (HI).
Low setting	Set the low set value(LSET) of low output (LO).
Output action (PSOT)selection	Among the output actions(OFF, HH, LH, HL, LL, IL), selecting "OFF" will not limit any functions to be operated but selecting various output types will allow only selected function to be operated.
Hysteresis setting	If the measured indication value starts to fluctuate minutely when it almost reaches the set value, it sets hysteresis in order to prevent the frequent output action

D

Panelmeter

Output

Communication output(RS485)	Able to set the address from 00 ~ 99 and able to select the baud rate of series transfer. (Transfer speed : 1200, 2400, 4800, 9600, 19200 bps)
Current output (transfer)	Yields the 4~20 mA DC output corresponding to the current indication value. (Resolving power: 12000)
Transistor output	PNP/NPN open collector output (12 – 24 V DC 50 mA max)
Relay output	1 a X 3 contact (HI, GO, LO), (220 V AC 5 A)

Standard specification

Power supply voltage	100 – 240 V AC, 50 – 60 Hz (Dual usage)
Voltage fluctuation	-15 ~ 10 % of the power supply voltage
Power consumption	Approx. 5 VA
Weight	300 g
Ambient temperature	0 ~ 50 °C
Ambient humidity	35 ~ 85 % RH
Storage temperature	-10 ~ 70 °C
Vibration resistance	10 – 55 Hz peak amplitude, to the each direction of X, Y, Z for 2 hour
Shock resistance	300 m/s ² , to the 6 direction of X, Y, Z and each 3 times

Default setting

● Setting group 1

Mode		Mode	Setting range	Default value
Symbol	English			
<i>1CTr</i>	1.CTR	Set CT ratio	•	100
<i>2Rdc</i>	2.ADC	Averaging numbers	1 ~ 25	10
<i>3SCH</i>	3.SCH	High scale	-1999 ~ 9999	0
<i>4SCL</i>	4.SCL	Low scale	-1999 ~ 9999	0
<i>5dPP</i>	5.DPP	Position of a decimal point	Temporal position setting	000.0
<i>6PDH</i>	6.PDH	Hold function	OFF, H-HD, L-HD, E-HD	OFF
<i>7LoC</i>	7.LOC	Lock function	ON, OFF	OFF
<i>8ADR</i>	8.ADR	Address	00 ~ 99	00
<i>9bPS</i>	9.BPS	Communication speed	1.2/2.4/4.8/9.6/19.2 K	9.6 K

● Setting group 2

Mode		Mode	Setting range	Default value
Symbol	English			
<i>HHPK</i>	HHPK	Max value display	-	-
<i>LLPK</i>	LLPK	Min value display	-	-
<i>HSET</i>	HSET	Max set value	-1999~9999	5000
<i>LSET</i>	LSET	Min set value	-1999~9999	2000
<i>PSoL</i>	PSOT	Output action selectable	LL,HH,LH,HL,IL	OFF
<i>HYSt</i>	HYST	Hysteresis	00~99	01

Comparative output mode (P5ot)

Operation mode	Output Operation	Explanation
	<p>H : Hysteresis</p>	
oFF		No output operation
LLot		Current indication value \leq LSEt value, LO output becomes ON. Current indication value $>$ LSEt value, GO output becomes ON.
HHot		Current indication value \geq HSEt value, HI output becomes ON. Current indication value $<$ HSEt value, GO output becomes ON.
LHot		Current indication value \leq LSEt value, LO output becomes ON. Current indication value \geq HSEt value, HI output becomes ON. Current indication value $>$ HSEt, then GO output becomes ON.
HLot		Current indication value \geq LSEt value, LO output becomes ON. Current indication value \geq HSEt value, HI output becomes ON. Current indication value $<$ HSEt and LSEt, GO output becomes ON.
iLot		Same as the LLot operation but LO output will not operate under the initial of LSEt . It starts to operate from the next value of LSEt .

→ It does not operate under the initial LSEt

Parameter(\overline{CT}) setting method by the Current Transformer (C.T) rate

(Current Transformers)		Parameter1 setting value	Calculated value (factor=1) Input voltage(V) x Input current(I)
Primary	Secondary	\overline{CT}	
5 A	5 A or 1 A	5	220 V x 5 A = 1100 W
10 A		10	220 V x 10 A = 2200 W
15 A		15	220 V x 15 A = 3300 W
20 A		20	220 V x 20 A = 4400 W
25 A		25	220 V x 25 A = 5500 W
30 A		30	220 V x 30 A = 6600 W
40 A		40	220 V x 40 A = 8800 W
50 A		50	220 V x 50 A = 11,00 kW
60 A		60	220 V x 60 A = 13,20 kW
75 A		75	220 V x 75 A = 16,50 kW
100 A		100	220 V x 100 A = 22,00 kW
120 A		120	220 V x 120 A = 26,40 kW
150 A		150	220 V x 150 A = 33,00 kW
200 A		200	220 V x 200 A = 44,00 kW
240 A		240	220 V x 240 A = 52,80 kW
250 A		250	220 V x 250 A = 55,00 kW
300 A		300	220 V x 300 A = 66,00 kW
400 A		400	220 V x 400 A = 88,00 kW
500 A		500	220 V x 500 A = 110,0 kW
600 A		600	220 V x 600 A = 132,0 kW
750 A	750	220 V x 750 A = 165,0 kW	
800 A	800	220 V x 800 A = 176,0 kW	
1000 A	1000	220 V x 1000 A = 220,0 kW	
1200 A	1200	220 V x 1200 A = 264,0 kW	
1500 A	1500	220 V x 1500 A = 330,0 kW	

※ Specifications 03 to 12 which use exclusive current transformer are irrelevant.



Parameter composition and setting method

- Parameter 1 (* Key - more than 2 sec)

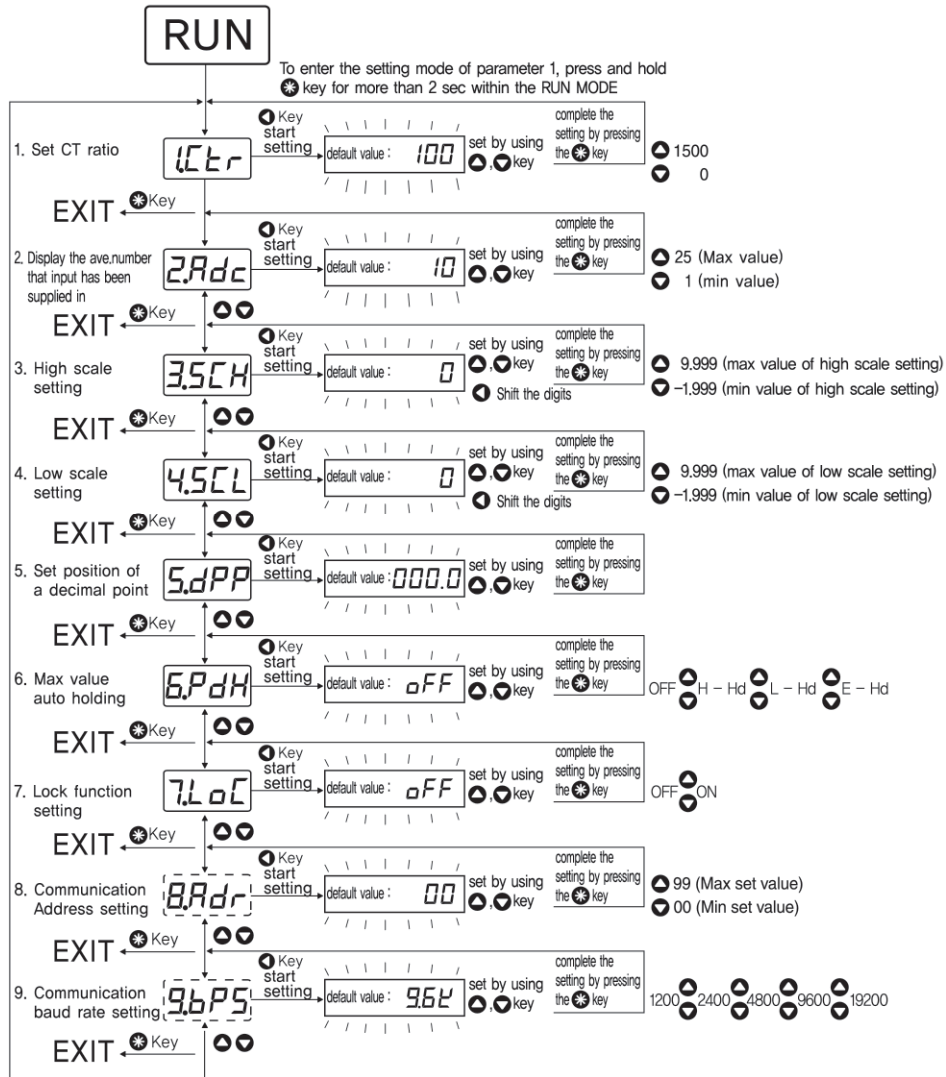

● Parameter 2 (* Key – more than 2 sec)

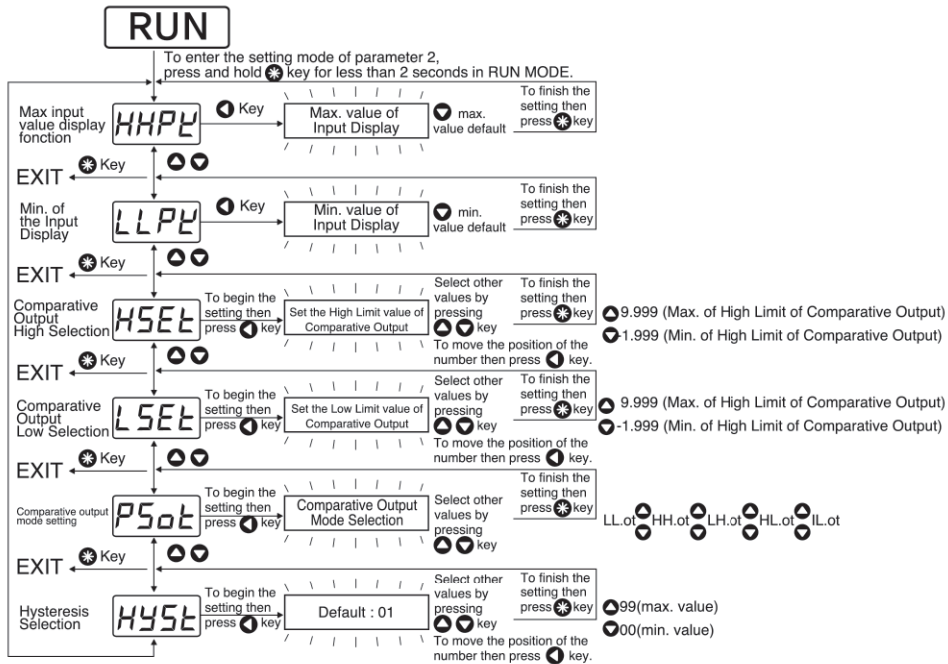

● Lock key (⏻ Key – more than 2 sec)

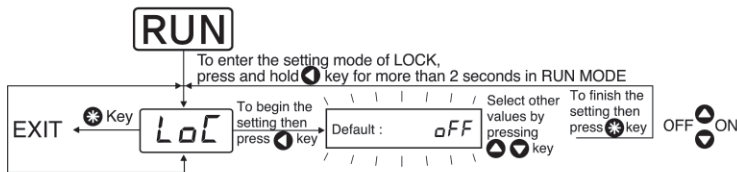

※ When LoC function is ON, it is impossible to set any of parameters.

● How to change the setting value of parameter

1. Pressing * key more than 2 sec within the RUN MODE will enter into the Parameter 1 and pressing * key less than 2 sec will enter into the parameter 2.
2. Able to select the parameter by pressing ▲, ▼ key and within the selected parameter, parameter and set value repeatedly flickers in the display unit.
3. Able to change the set value by pressing the ◀ key and at this moment, set value flickers in the display unit

When changing the setting of constant value, able to perform the position shifting by using ◀ key.

Example)

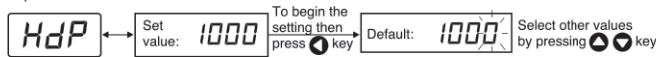

When set value is constant, only 0th digit of the constant value will flicker in the display unit.

In order to change the value of 100th digit, press the ◀ key 3 times. Each time when users press the ◀ key, position of the digit will shift to the left and selected digit will flicker in the display unit.

When setting is completed, return to the parameter mode by pressing the * key. At this moment, please flickers the parameter and set value repeatedly once again. Able to return to the RUN mode by pressing the * key again.



● Setting method for the special specification of current transforming ratio

Ex) When the ratio of C.T is 350A:5A, it is same as the parameter 1 setting method (350A:1A).

When C.T ratio is 350A:5A, power calculation is 220V * 350A = 77.00 kW. (Factor = 1)

- A . Press the * key for more than 2 sec in order to enter in the parameter 1 mode.
- B . Move to the SCH mode by pressing ▲, ▼ key. (2.SCH and 0 will be displayed repeatedly).
- C . Pressing the ◀ key will make indicated value flickers. (shift a position of digits ◀ key)
- D . Set to 7700 by pressing ▲, ▼ key
- E . Once setting is completed, press the * key to return to the main.

Parameter 1		
Parameter	SCH	DPP (Decimal point)
Set value	7700	00.00

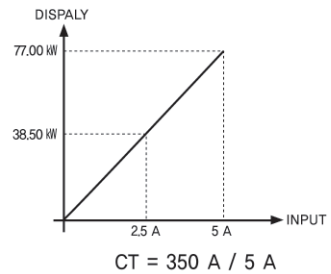

● Defaulting set values

While pressing ▲ key, press the key * → ◀ → ▼ then **EESE** will be displayed.

At that time, press ▲ key again then all the set values will be defaulted.

(If **LoCE** function is ON, it is impossible to default)

Error display code

-HH-	: This will be displayed when it is higher than Max Range 9999 (for 4 digits model) or a negative number is appeared in Normal mode. Normal mode: SCH 0 or SCL 0
OBEr	: This will be displayed when a measured input value exceeded max input range.
HLEr	: Error message will be displayed when a setting value of High Comparative Output is less than that of Low Comparative Output

● Transfer Function (Auxiliary Output)

- RS 485 communication
 - Able to transmit by assigning address from 00 to 99 and by selecting modulation speed of Serial Transmission.
 - Transfer speed(BPS) setting selection : (1200, 2400, 4800, 9600, 19200)
 - Current output
 - Generate 4 – 20 mA DC for a present displayed value (Resolving power 12000)
 - PNP output (open collector output 12 – 24 V DC below 50 mA)
 - NPN output (open collector output 12 – 24 V DC below 50 mA)
 - RELAY output (250 V AC below 5 A) 1a × 3
- ※ Cautious) WM3 is known as the power meter with cycle measurement method.
 Indication time can be slowed down if input is less than 2% of the max input.
 (Max 2 sec)

● Dimension and panel cutout (unit : mm)

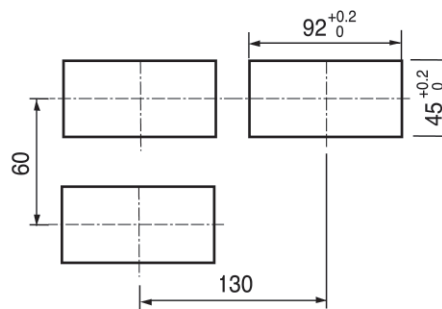
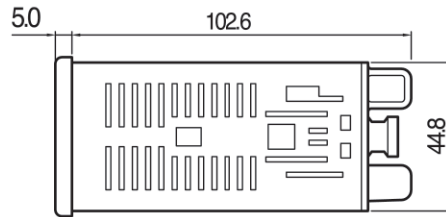
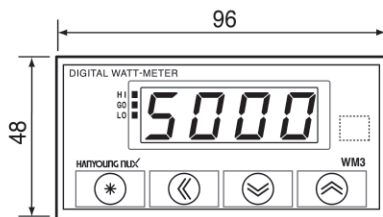

● Connection diagram

- WM3-41□N

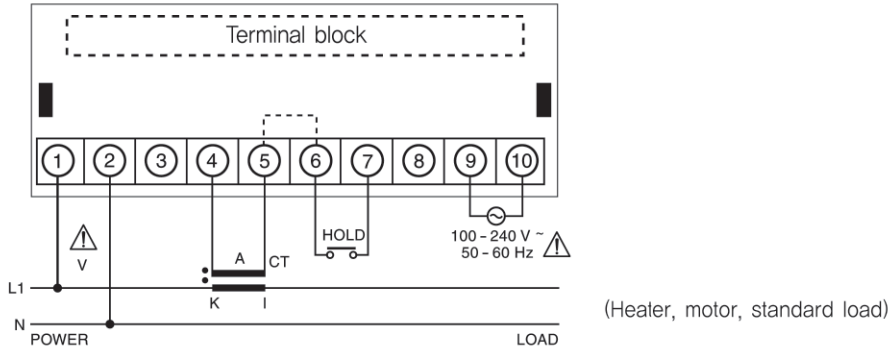

D
Panelmeter

■ Auxiliary output

- WM3-41□0 (Relay output, 4-20 mA current output)

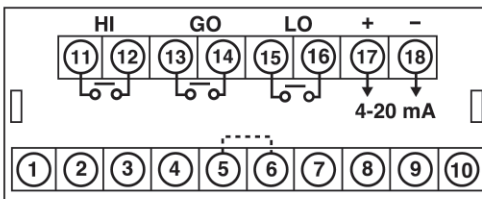

- WM3-41□1 (Relay output)

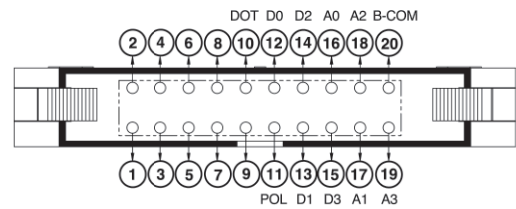

- WM3-41□2 (NPN TR, 4-20 mA current output)

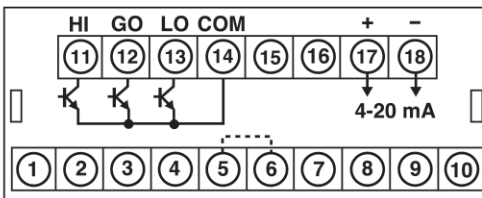

- WM3-41□3 (PNP TR, 4-20 mA current output)

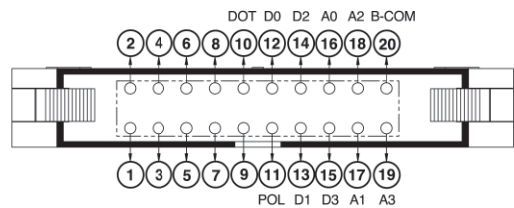

- WM3-41□4 (NPN TR, RS485)

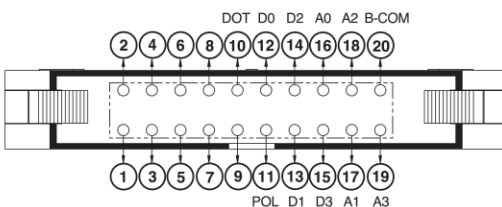

- WM3-41□5 (PNP TR, RS485)

