

PEN Series

Photo Sensor

- Long distance detection
- IP 64 structure
- Stable LED
- Applied the inverter light noise preventing circuit (B Type)



Suffix code

Model	Code	Description
PEN-	<input type="checkbox"/> <input type="checkbox"/> <input type="checkbox"/>	Photo Sensor
Sensing method and Sensing distance	T 10	Through-beam 10 m
	M 5	Retro-reflection 0.1 – 5 m
	R 700	Diffuse reflection 700 mm
Power supply voltage	A	24 – 240 V AC/DC ± 10 % 50/60 Hz
	B	12 – 24 V DC ± 10 %

G

Photo Sensor

Specification

Model	Power built in		
	PEN-T10A	PEN-M5A	PEN-R700A
Sensing method	Through beam type	Retro reflection type	Diffuse reflection type
Sensing distance	10 m	0.1 ~ 5 m	700 mm
Sensing object	min $\varnothing 20$ mm (Opaque body)	min $\varnothing 60$ mm (Opaque body)	200X200 mm (White non-glossy paper)
Power supply voltage	24 – 240 V AC/DC (Dual usage) ± 10 % 50/60 Hz		
Power consumption	Emitter : max 1 W Receiver : max 2 W	max 2 W	
Operation mode	Light ON / Dark ON ※ Selectable by mode V/R		
Sensitivity adjustment	—	Built in the sensitivity control V/R	
Control output	Relay output (Contact composition 1a, 1b) – Contact capacity : 30 V DC 5 A / 250 V AC 5 A Resistive load Rated load life expectancy – min 100 thousand times		
Response time	max 20 ms		
Hysteresis	—	Less than 20% of the sensing distance	
Light source	Infrared lightening LED (Alternation type)		
LED	Control output indicator : Red LED, stable output indicator : green LED (Red LED of through beam type emitter is the power indicator)		
Material	Case : Heat resistance ABS, Lens : P.C		
Protective circuit	—		
Connection method	Cable extended type (Number of wire : 5P, Diameter : $\varnothing 6$ mm, Length : 2 mm) ※ Emitter 2P		

Ambient illumination	Sunlight : max 11000 Lux, Incandescent lamp: max 3000 Lux
Ambient temperature	-20 ~ 65 °C (surrounding storage temperature : -25~70 °C)
Ambient humidity	35 ~ 85 % RH (with no condensation)
Protective structure	IP 64 (IEC)
Vibration resistance	10 - 55 Hz double amplitude 0.75 mm, for 2 hours each in X, Y and Z directions (But within the power-off state)
Dielectric strength	1,000 V AC (50/60 Hz for 1 min)
Shock resistance	500 % (Approx. 50 G), 3 times each in X, Y and Z directions
Insulation resistance	min 20 MΩ (500 V DC mega between the charging part and case)

Model	Amp built in		
	PEN-T10B	PEN-M5B	PEN-R700B
Sensing method	Through beam type	Retro reflection type	Diffuse reflection type
Sensing distance	10 m	0.1 ~ 5 m	700 mm
Sensing object	min Ø20 mm (Opaque body)	min Ø60 mm (Opaque body)	200X200 mm (White non-glossy paper)
Power supply voltage	12 - 24 V DC ±10 %		
Current consumption	Emitter : max 35 mA Receiver : max 20 mA	max 45 mA	
Operation mode	Light ON / Dark ON ※ Selectable by the mode V/R		
Sensitivity adjustment	—	Built in the sensitivity control V/R	
Control output	NPN/PNP open collector output asynchronously Load current : Max, 150 mA DC (Resistive load), Remaining voltage : Less than 1 V DC		
Response time	max 1 ms		
Hysteresis	—	Less than 20 % of the sensing distance	
Light source	Infrared lightening LED (Alternation type)		
LED	Control output indicator : Red LED, stable output indicator : green LED (Red LED of through beam type emitter is the power indicator)		
Material	Case : Heat resistance ABS, Lens : P.C		
Protective circuit	Built in the reversed power supply connection protective circuit, short protective circuit and inverter light noise protective circuit.		
Connection method	Code extended type (Number of wires : 4P, Diameter : Ø 6 mm, Length : 2 mm) ※ Emitter 2P		
Ambient illumination	Sunlight : max 11000 Lux, Incandescent lamp : max 3000 Lux		
Ambient temperature	-20 ~ 65 °C (Surrounding storage temperature : -25~70 °C)		
Ambient humidity	35 ~ 85 % RH (With no condensation)		
Protective structure	IP 64 (IEC)		
Vibration resistance	0 - 55 Hz double amplitude 0.75 mm, for 2 hours each in X, Y and Z directions (But with the state when power being OFF)		
Dielectric strength	1,000 V AC (50/60 Hz for 1 min)		
Shock resistance	500 % (Approx. 50 G), 3 times each in X, Y and Z directions		
Insulation resistance	min 20 MΩ (500 V DC mega between the charging part and case)		

Note 1) The sensing distance can be varied depending on the size, surface condition, glossy, non-glossy of the sensing object

(Note 2) In case of the through beam type, it is a set of the PEN-TL10□, emitter, and PEN-TR10□, receiver (□ : Power suppl voltage selection, A or B)

(Note 3) Sensing range of PEN-M5A (B) is a distance when HY-M5 (Mirror) is used



Photo Sensor

Dimension (Unit : mm)

Dimension

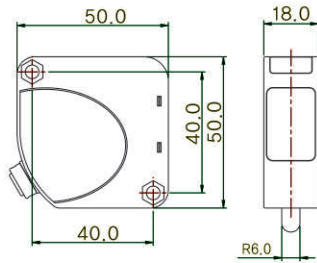

Mirror (HY-M5)

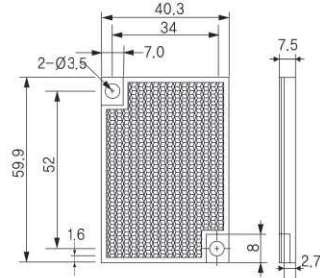

Bracket installed

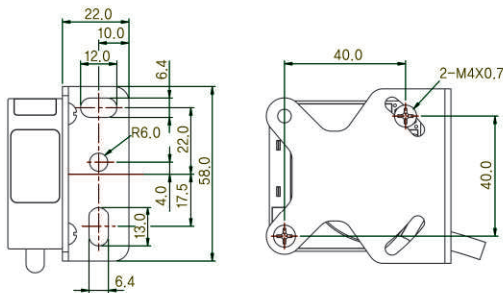

Connection diagram

PEN - A (Through beam type only uses the receiver)

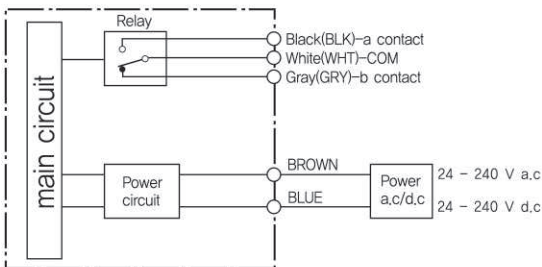

PEN - B (Through beam type only uses the receiver)

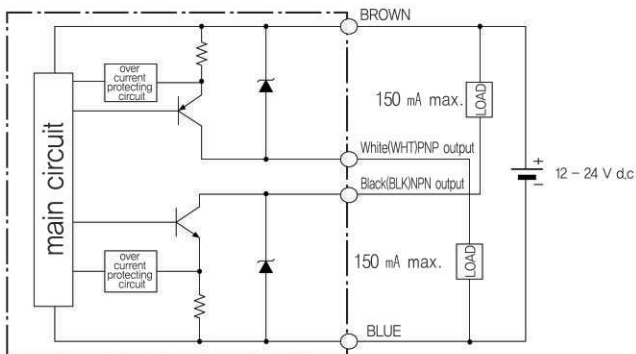

⦿ Operation chart

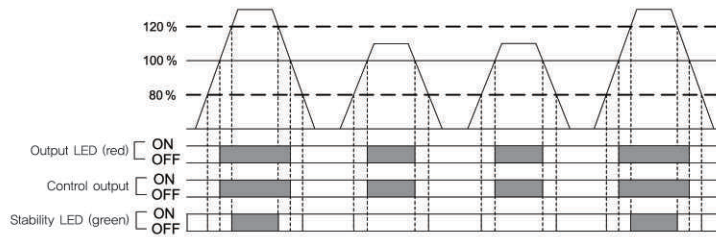

L.ON operation

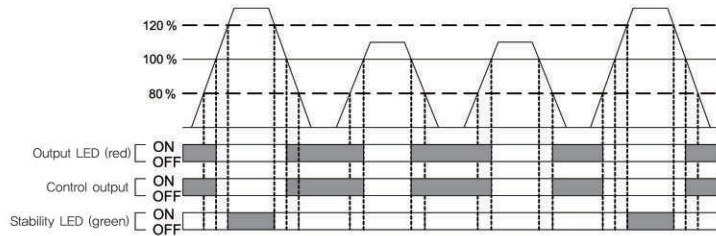

D.ON operation

⦿ How to install

■ Through beam type

Order	Installation method	Set image	Output mode
1	Supply in the power after placing the emitter and receiver to face each other in the straight line		Dark ON
2	Fix either the emitter or receiver and check for the range where output indicator becomes turned OFF by controlling the other in the direction of up, down, left and right. After finishing the confirmation, place it in the middle and fix it.		
3	Place the sensing object within the setting range and confirm the condition of proper operation and once the confirmation is finished, fix the sensor.		

■ Retro reflection type

Order	Installation method	Set image	Output mode
1	Supply in the power after placing the sensor and mirror to face each other in the straight line		Dark ON
2	Fix either the sensor or mirror and check for the range where output indicator becomes turned OFF by controlling the other in the direction of up, down, left and right. After finishing the confirmation, place it in the middle and fix it.		
3	Place the sensing object within the setting range and confirm the condition of proper operation and once the confirmation is finished, fix the sensor.		

■ Diffusion reflection type

Order	Installation method	Set image	Sensitivity volume	Output mode
1	After removing the sensing object, turn sensitivity volume gradually to the max direction and once operation indicator lights up, that position will be referred as 'A' from now on. (If the indicator does not get turned ON even in the position of maximum then it is max)			Light ON
2	Place the sensing object in the desirable setting position and gradually turn the sensitivity volume from 'A' to the 'Min' direction and once the indicator gets to be turned OFF than that position will be referred as 'B'.			
3	Place the sensitivity volume in the middle of max sensitivity and 'A' confirm the operation condition of sensing object that occurs within the setting range After that fix the sensor.			

● Characteristic of sensing range

■ PEN-R700A / PEN-R700B

Distance(cm)	Unit(mm)	
0	0	0
10	10.5	-10.5
20	13.5	-13.5
30	16.5	-16.5
40	15.5	-15.5
50	15.5	-15.5
60	14	-14
70	10.5	-10.5
80	5	-5

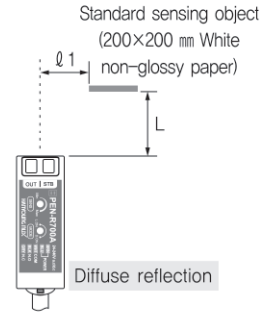
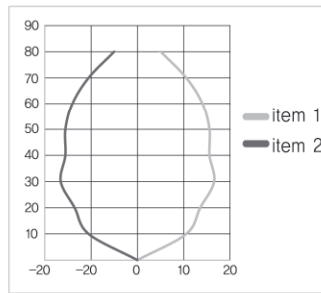

■ PEN-M5A / PEN-M5B

Distance(cm)	Unit(mm)	
0	0	0
1	11	-11
2	16.7	-16.7
3	47.2	-47.2
4	70.9	-70.9
5	115.5	-115.5
6	112.8	-112.8

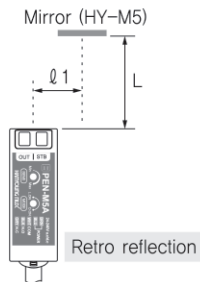
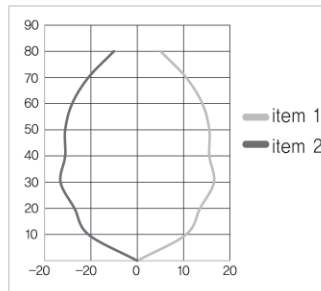

■ PEN-T10A / PEN-T10B

Distance(cm)	Unit(mm)	
0	0	0
1	111.5	-111.5
2	215.3	-215.3
3	286.7	-286.7
4	332.6	-332.6
5	296.3	-296.3
6	286.5	-286.5
7	244.7	-244.7
8	288.2	-288.2
9	307.2	-307.2
10	332.2	-332.2
11	347.6	-347.6

